

NOTE: FOR MORE DETAILS SEE YOUR V.P.CUSTOMER SERVICE REP.

REVISIONS			
REV.	DESCRIPTION	DATE	APPROVED
A	INITIAL RELEASE	11-28-97	
B	CO 046 Drafting Update	11-29-07	Rick C.

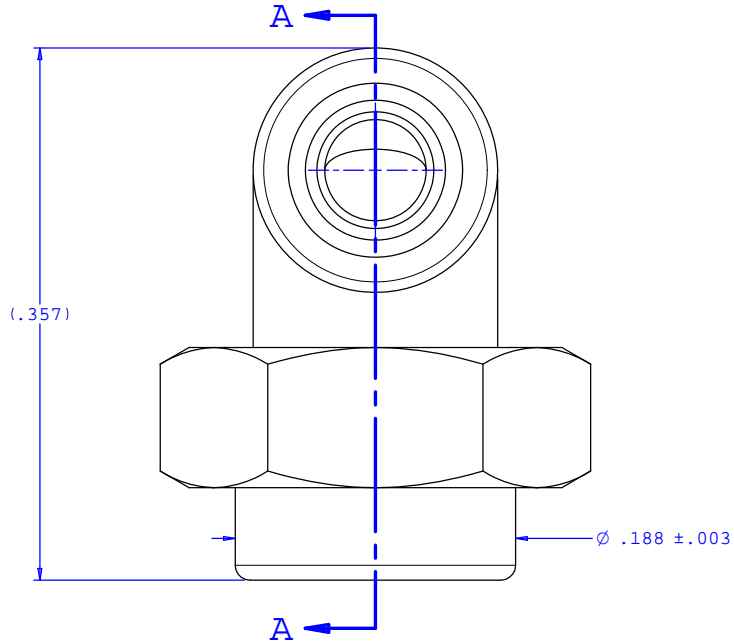

INSTRUMENT QUALITY PART. NO PARTING LINE PERMITTED ON THIS CONICAL SURFACE

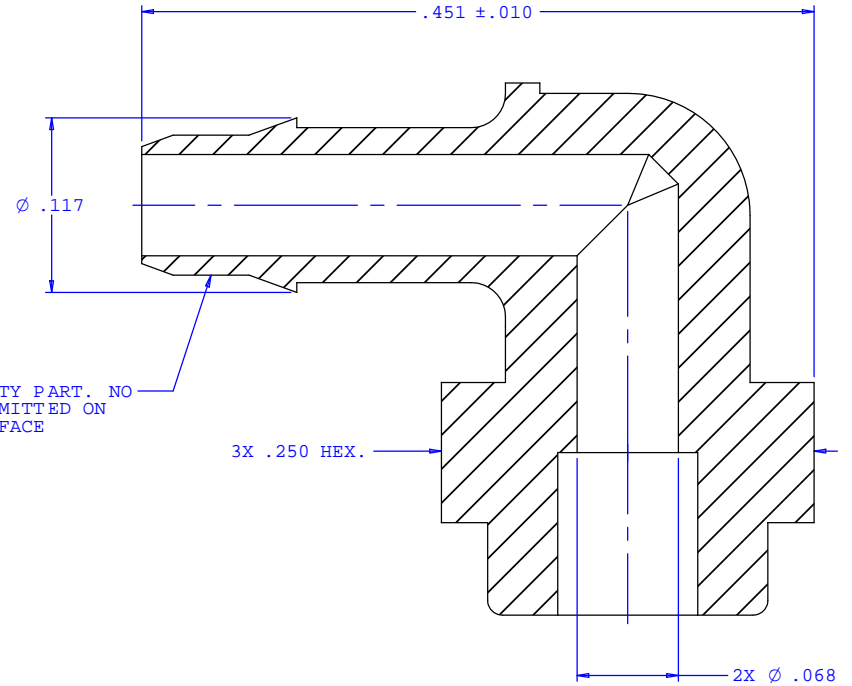

SECTION A-A

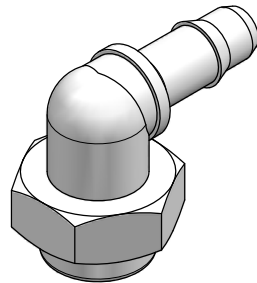

UNLESS OTHERWISE SPECIFIED DIMENSIONS ARE IN INCHES TOLERANCES ARE:		VALUE PLASTICS, INC.	
FRACTIONS ±	DECIMALS .XX ±.01 .XXX ±.005 .XXXX ±.001	ANGULAR ±1°	PART NUMBER: BDML420
DO NOT SCALE DRAWING		DESCRIPTION: Bondable Elbow 400 Series Barb, 3/32" (2.25 mm) ID Tubing	
DRAWN BY: Frank Lombardi	DATE: 05-05-06	SIZE: B SCALE: NTS	DRAWING NUMBER: 1008765 REV. B
Engineer/Manager: Rick Cairns		© 2006 VALUE PLASTICS, INC. SHEET: 1 OF 1	

FOR REFERENCE ONLY